

GTV



EASY in selection
and **FAST** in installation
of furniture lighting system

Furniture lighting accompanies us for over two decades, illuminating kitchen cupboards, cabinets and wardrobes. Deciding on such a solution, we do not directly use 230V voltage, but 12V that is safe for humans.

The whole set is not complicated - it invariably consists of three basic elements: a LED driver (changing the voltage from 230 to 12 V), a switch and a light source.

However, when installing it, you should plan the entire system, which includes:

- Mountings;
- Couplings;
- End caps;
- Covers;
- Distributors;
- Connectors;
- Power cables;
- Recalculation of power consumption of light sources;
- Choosing a LED driver with an appropriate power reserve.

For all this you need some soldering skills (the pads on the LED strips are really very small) and at least 2 screwdrivers to connect the LED driver to the power cable and switch.

If at this point you think that completing the entire set and subsequent installation is beyond your capabilities, the **EASY CLICK system is just the solution FOR YOU!**

Or maybe you already know everything and you have been installing lighting for years and nothing will surprise you. If this is the case, then you definitely know how long it takes to prepare the components. What if this time could be shortened by 70%? All LED strips, switches, and even the LED driver have miniAMP connectors. **All you have to do is CLICK!** You still believe that **EASY CLICK** is not for you?

Suffice it to describe the final effect and EASY CLICK will do the rest for you!

ARRANGEMENT PLANNING

Take a look at your furniture and decide where you need light. If it makes it easier for you, you can make a sketch and mark it with any colour!



IMPORTANT - each line of light you mark needs a separate switch!
You can pre-define their location now.

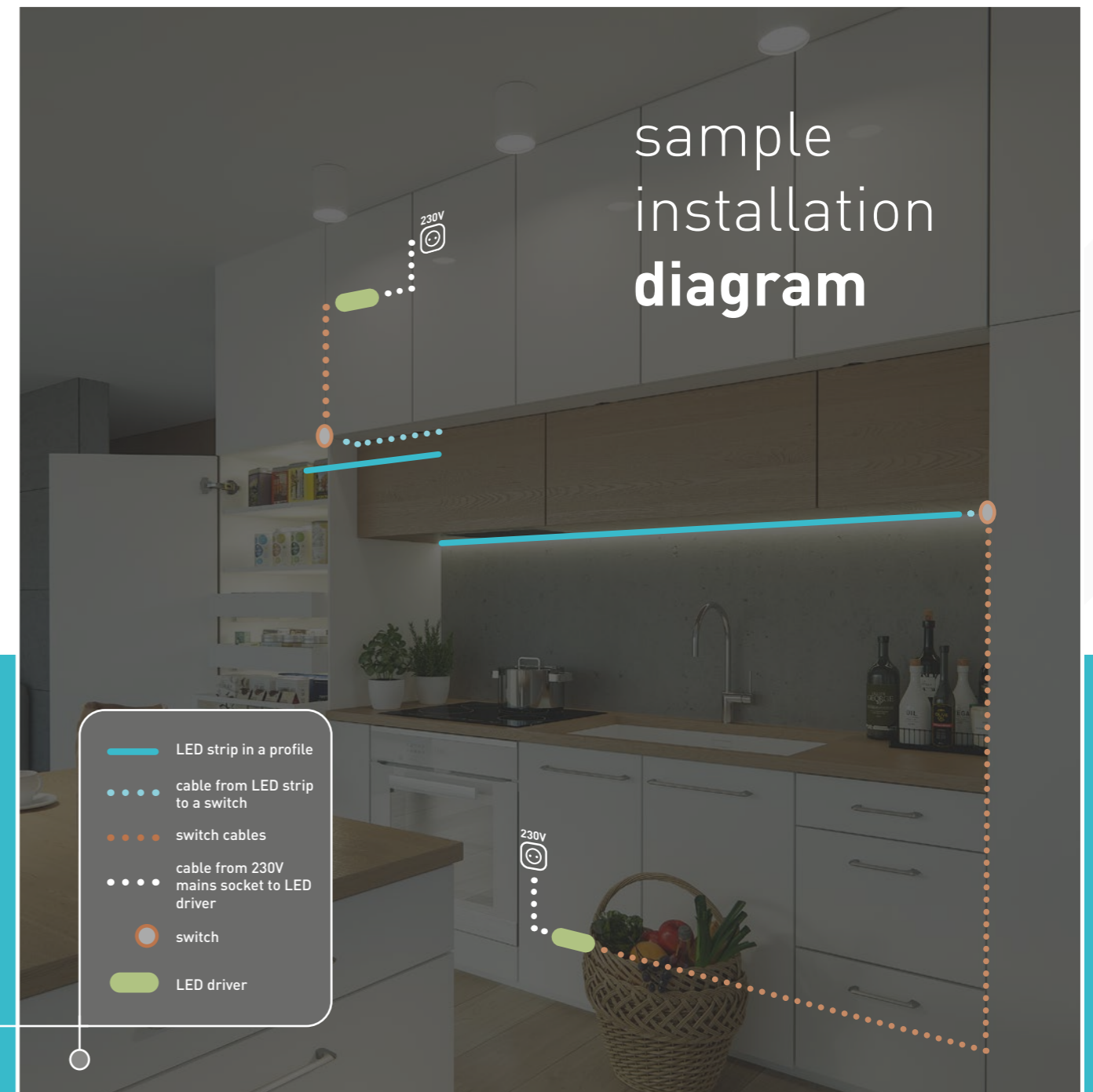
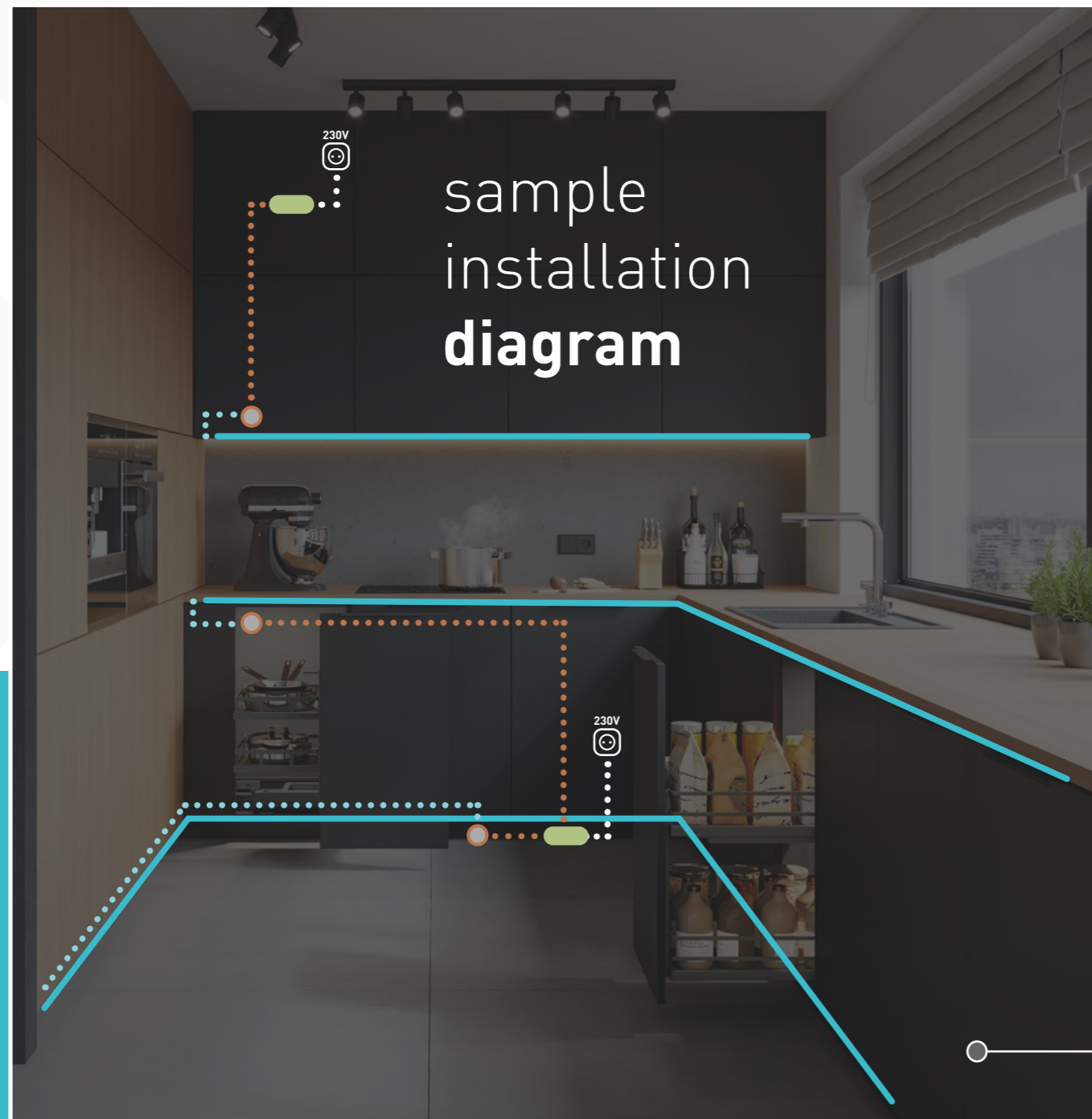

COMPLETE A SET

The most difficult task has already been completed. Now it remains to follow the directions and choose from the predefined elements.

Complete the **EASY CLICK** set in **5 steps**

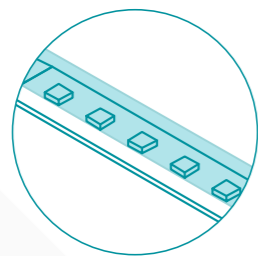

select the number of sections of LED strips

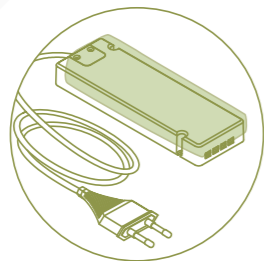

choose a **profile**

- profiles are sold as ready-made 2m sets, including a profile, a cover and 2 end caps

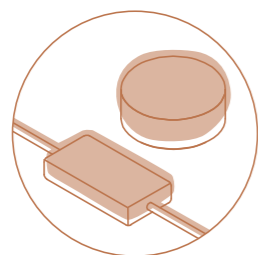

1. choose a **LED strip**

2.

3. dedicated **LED driver**

4.

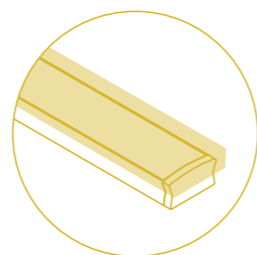

5. select a **switch**

LED STRIPS

We think about your comfort in the **EASY CLICK** system, therefore you do not have to compare dozens of products yourself, wondering whether they will fit in the profile or what power consumption it has. You do not feel like an expert in precision soldering? Neither do we.

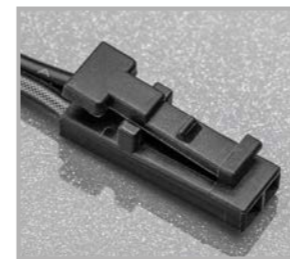

Each LED strip has a factory-made power cable with a length of 2 meters, finished with a miniAMP connector.

LED STRIP COB



LED strips with COB technology are popular in many interiors, offices and shops. They differ from traditional strips based on SMD LEDs because in COB they create an even line of light without visible points, which is the result of very densely arranged LEDs. An important parameter for COB strips is the colour rendering index, which in this case reaches CRI>90.

In the Easy Click system, COB LED strip is supplied in a 5 metre roll, with a 1 metre power cable and mini AMP connectors at both ends. This makes installation much easier, especially when lighting kitchens in L or C configurations. Thanks to special, transparent connectors, the light line can be directed without restrictions.

When choosing a LED strip, it is worth paying attention to the density of LEDs per metre. We have options of 320 LEDs/m (700 lm/m) or 480 LEDs/m (800 lm/m). This directly affects the brightness of the emitted light. The more LEDs on the metre, the brighter the strip shines.



CONNECTORS

In the **EASY CLICK** system, the COB LED strip is supplied in five-metre rolls terminated on both sides with power cables with a mini AMP male connector. If only two sections are used in the project, the issue of powering the strips is simple. However, what if the project includes four one-metre sections or the kitchen has an L or C configuration? Will we have to solder the cables? Of course not! In such situations, dedicated connectors can be used.

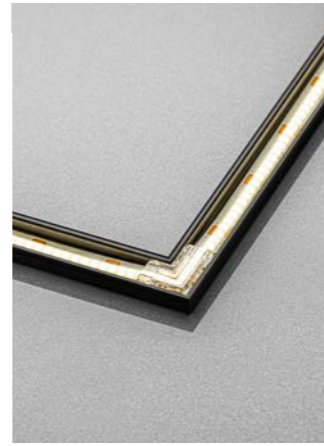

Various types of connectors are available:

- ◆ powering with a 2-metre cable and a mini amp male connector;
- ◆ connecting with a 15 cm cable;
- ◆ connecting linear;
- ◆ angular 90 degrees.

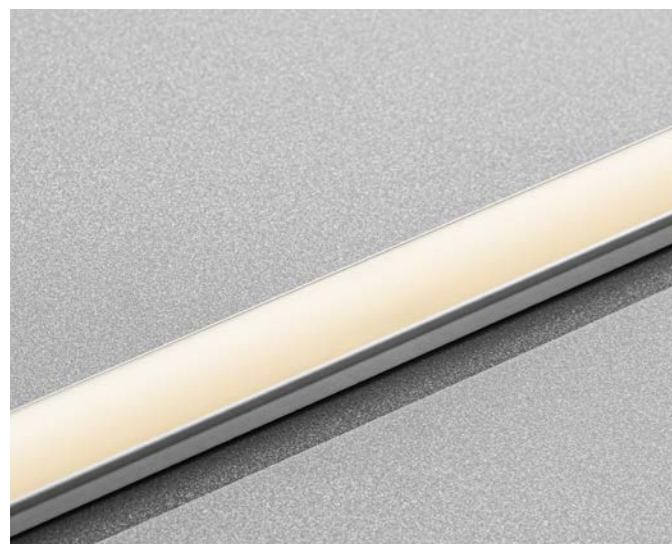
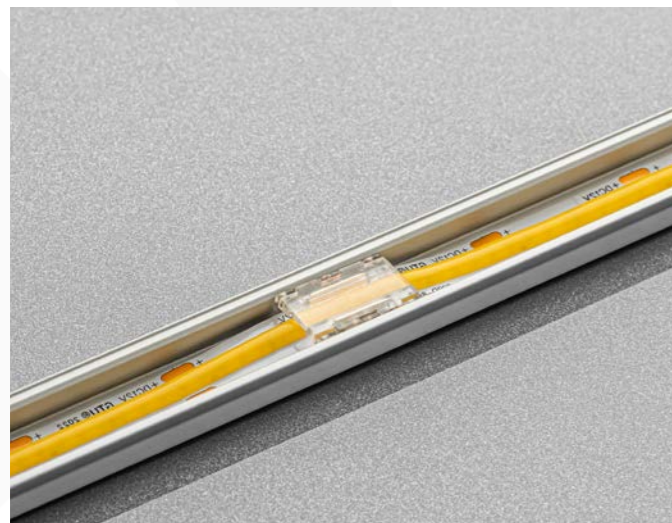
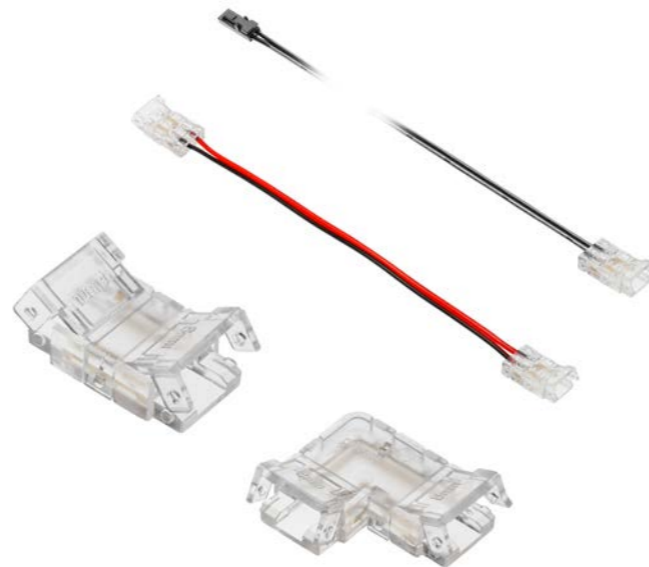

In linear lighting, it is extremely important that there are no breaks in the light line. It is possible thanks to the use of transparent connectors that let light through after the strip is attached. Additionally, these connectors are designed in such a way that the strip does not slip out of them. They have small teeth that actually bite into the COB strip, enabling a stable connection even if we miss the soldering pads. An important issue is the minimal size of the connectors, they fit into standard GLAX profiles as well as in mini profiles.



COLOUR TEMPERATURE



Light, its distribution, location and intensity play an extremely important role. But we cannot forget about its colour temperature. Yes, light has a colour temperature parameter, commonly known as the light colour. It is expressed in the number of Kelvin 3000K, 4000K or 6000K. Not being a specialist in this field, it is difficult to define which range we will need.

In this summary, everything should become CLEAR!

3000 K warm white



The warm light colour temperature is most often used in places of rest and relaxation: **living room, bedroom, children's room**

4000 K neutral white



The neutral light colour temperature is a universal solution because it resembles daylight: **kitchen, bathroom, office.**

6400 K cold white



The cold light colour temperature is conducive to focus on precise work: **design offices, doctor's offices, model-making studios.**

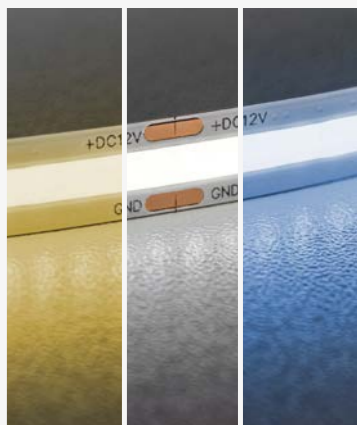

2

NUMBER OF SECTIONS OF LED STRIPS

It is necessary for the correct selection of the LED driver. If you did not mark them on the diagram, now this is the right time to do so.



1, 2, 3 ...

Consider how many sections of LED strips you need.

3

DEDICATED LED DRIVER

This step has caused the biggest problem to users so far. Therefore, we have made all the calculations for you.



After all, I will shorten this LED strip. Will it fit?

Don't think about it. Use CONFIGURATOR!



configurator

The LED driver is the heart of the entire system. It has to be efficient and reliable. It is no different in the Easy Click system. Our heart is a highly specialized switching LED driver with a power cable connected by a factory and built-in miniAMP sockets.

Professionals will appreciate parameters such as:

- ◆ EMC filter;
- ◆ surge protection filter;
- ◆ maximum socket load 3A;
- ◆ power consumption in standby mode is less than 1W;
- ◆ meets the latest European standards;
- ◆ casing in a slim version;
- ◆ 1.5 m long power cable.

4

PROFILE

Profiles for LED strips, in addition to their aesthetic function, are designed to dissipate heat emitted by the LED strip, thus protecting it from wear too early. Therefore, it is very important, although often overlooked activity, to degrease the profile before sticking the LED strip - it should adhere to the profile with its entire surface.

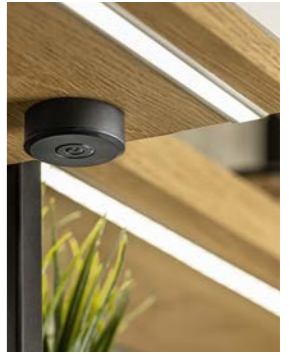

REMEMBER!

number of profiles = number of the LED strip sections



IMPORTANT - if necessary, shorten the profile with the cover clicked, it will allow for a perfect fit of both elements.

By selecting the profile and its colour, you will get a set which includes:

- ◆ 2 meter profile;
- ◆ 2 meter milky cover;
- ◆ 2 end caps.

Surface mounted profiles

are one of the most popular because they are the easiest to install.



watch a video

- PA-ZGLAXMNMK0MZ-00
- PA-ZGLAXMNMK0MZ-20M
- PA-ZGLAXMNMK0MZ-10

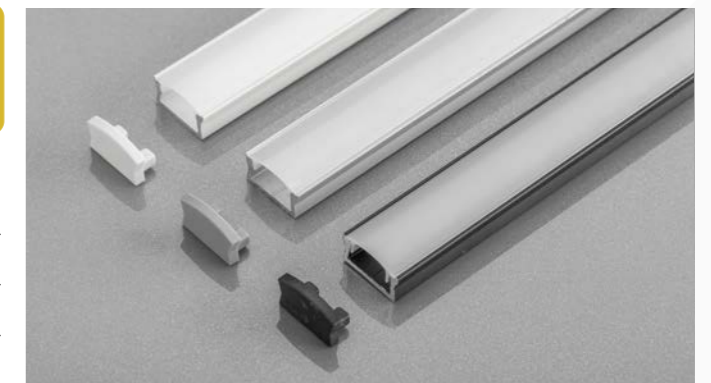
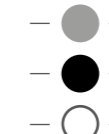

If you need more detailed information on the installation of profiles, you will find a complete compendium of knowledge here.



Surface mounted profiles, corner



- PA-ZGLAXKT0MZ-00
- PA-ZGLAXNKK0MZ-20M
- PA-ZGLAXNKK0MZ-10

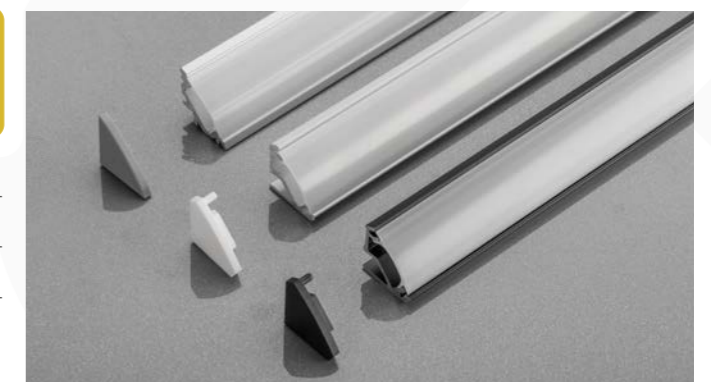
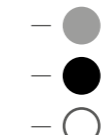

Recessed profiles

are intended for professionals because they require precise milling.

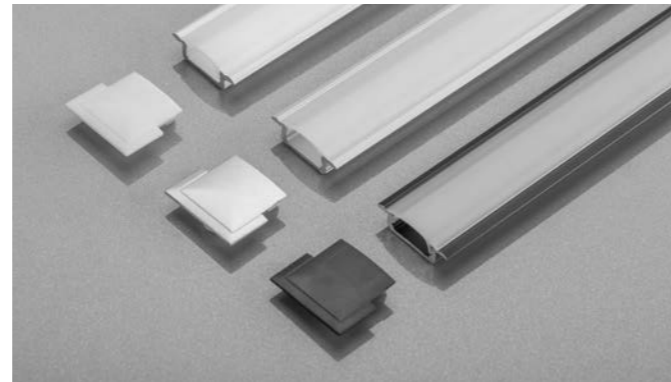

watch a video

PA-ZGLAXOMZ-00

PA-ZGLAXOMZ-20M

PA-ZGLAXOMZ-10



If you need more detailed information on the installation of profiles, you will find a complete compendium of knowledge here.



SWITCHES

They determine the comfortable use of the lighting that will be installed. At this stage, you also do not have to compare their parameters, just define your needs and everything will match. Just remember about the appropriate number of switches 1 switch = 1 section of the LED strip.



OUR RECOMMENDATION

Wireless switch - is the most convenient solution that you can imagine. It consists of two elements: a controller and a switch. These two elements communicate wirelessly and the maximum distance between them is as much as 12 meters. This solution allows you to place the switch literally everywhere.



IMPORTANT - the switches can be selected independently of each other. Each of them can be used in a different place.



IMPORTANT - the switch can also be installed in the recessed variant Ø35 mm.



Installation scheme

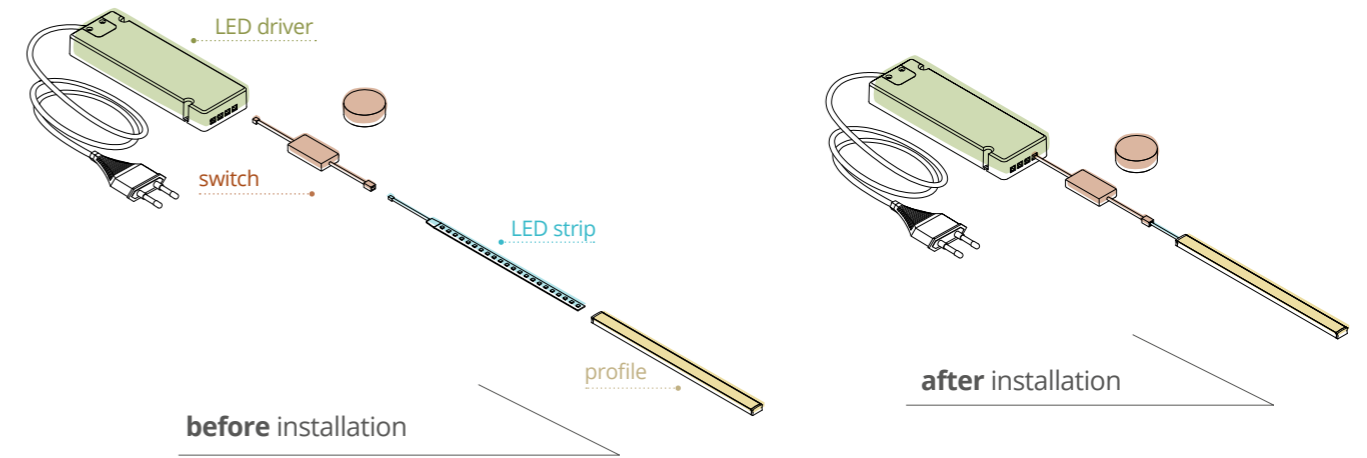

The most popular solutions are switches equipped with cables (to the LED driver and to the LED strip). The initial division is made in two steps: **TOUCH / TOUCHLESS** and **DIMMABLE / NON-DIMMABLE**. The result of such a division will be 1, maximum 2 switches. Each of them will have slightly different characteristic, but no matter which one you choose, it will be compatible with the previously selected elements.

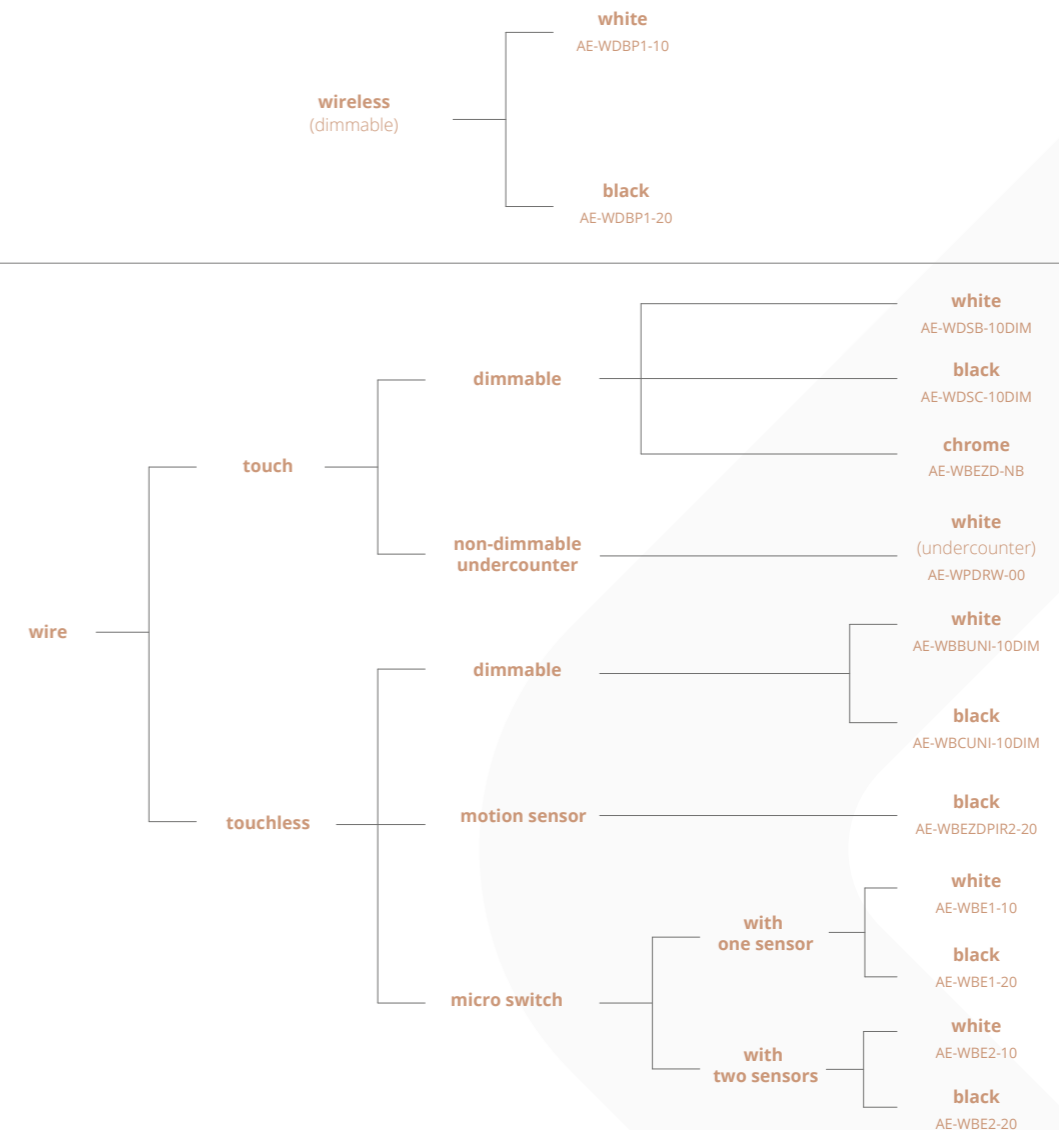

DIMMABLE TOUCH SWITCHES

One of the ways to facilitate everyday functioning in a modern space is a touch switch with a dimming function. Its undoubted advantage is its small size, comparable to a button. In combination with the recessed mounting, it ensures high discretion and minimalist aesthetics.

- ◆ The switch is dedicated to power under-cupboards fittings and LED strips.
- ◆ The dimming function is activated by pressing the switch for a long time.
- ◆ Easy to mount and connect. The mounting hole is only 18mm in diameter.
- ◆ Aesthetic finish and minimalist form make the switch a universal element of furniture.

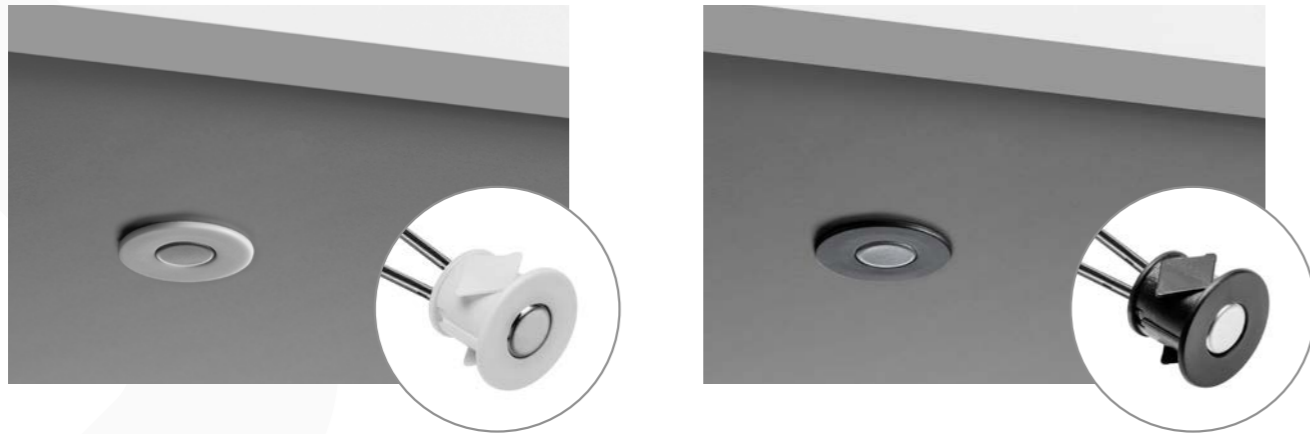

You should remember that in furniture made of a high-gloss lacquered board the remaining elements should have a similar finish. The universal, chrome finish will match any colour. It will be easy to find the switch at night thanks to the delicate blue illumination.

- ◆ The switch is dedicated to power under-cupboards fittings and LED strips.
- ◆ The dimming function is activated by pressing the switch for a long time.
- ◆ Additional blue backlight of the switch.



NON-DIMMABLE UNDERCOUNTER SWITCH

The switch is placed under a countertop with a maximum thickness of 40 mm. It reacts to the shock generated by lightly touching the surface of the countertop in the area where the device is located. A very smart solution for all those who like minimalism.

- ◆ The maximum thickness of the countertop is 40 mm.
- ◆ After installation, the sensor is completely invisible.

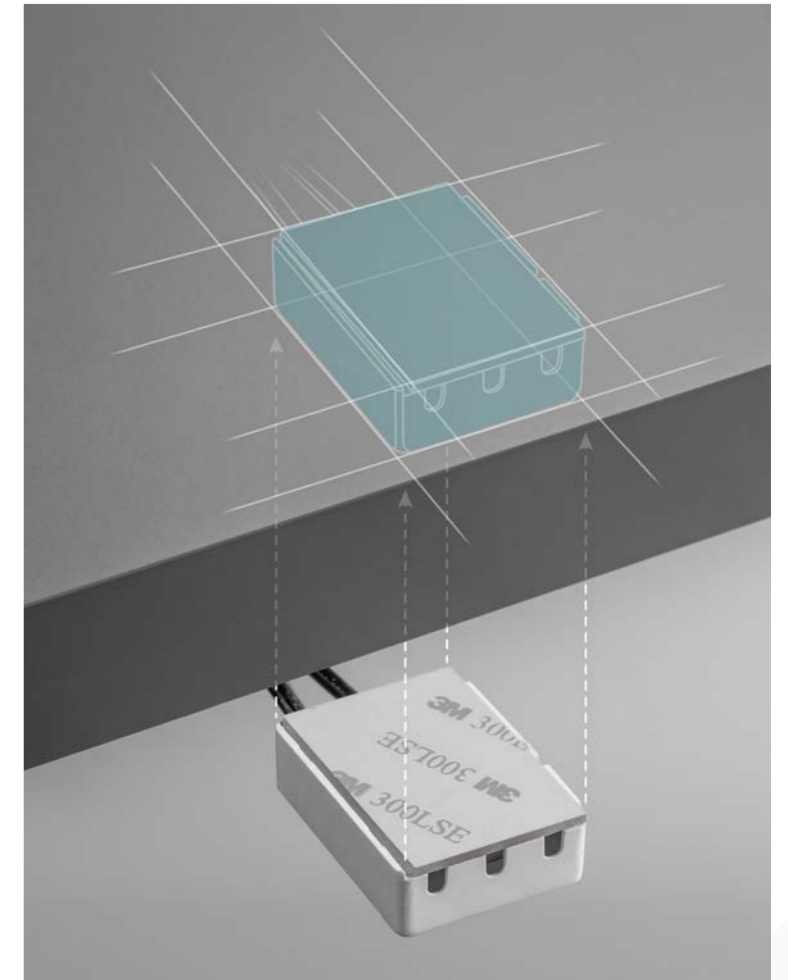

DIMMING TOUCHLESS SWITCH

2 in 1 touchless switch can be used as:

- ◆ single-pole switch, the so-called Doorway (as long as it sees an obstacle, the light is off);
- ◆ two-pole switch reacting to movement, e.g. a wave of hand.

In two-pole mode, it can also be used as a dimmer. The view range of the sensor is approximately 5-6 cm.



MICRO TOUCHLESS SWITCH

Minimalist interiors blend perfectly with touchless micro switches. Thanks to the small size of the sensor, they are almost imperceptible, which fits perfectly into the minimalist style. Micro switches are available in two variants: for one and two doors.

The switches operate in single-pole mode, also called door mode. This means that as long as the sensor detects an obstacle, the light remains off, thus saving energy.

Thanks to this solution, in addition to functionality, we also gain an aesthetic convenience that fits perfectly the minimalist character of the rooms.

- ◆ single-pole (door);
- ◆ version for 1 or 2 doors;
- ◆ minimum installation size;
- ◆ application handle included.



NON-DIMMABLE MOTION SENSOR

The switch is equipped with two small motion sensors that react to changes of temperature against the environment. Their detection range is approximately 2 meters. Due to their character, they should be installed inside cabinets. After opening, for example, the wardrobe door, the sensor detects the human body warmer than the environment and turns on the light.

The runtime of light after the object leaves „the field of view“ of the sensor is about 45 seconds.

If you do not need both sensors, you can easily disconnect one by unfastening the miniAMP connector.

- ◆ two sensors;
- ◆ detection range 2 m;
- ◆ IR sensor.



Thanks to predefined components and reliable product selection schemes, **EASY CLICK** allows the user to design freely without time-consuming analysis and calculations. The installation time is reduced to a minimum, as all elements are clicked by means of connectors. A wide range of colours, shapes and

functionalities of the switches allows you to implement any lighting project.

What will be yours?







GTV

ul. Przejazdowa 21
05-800 Pruszków
Poland

 +48 22 44 47 272

 +48 22 44 47 366
+48 22 44 47 331

 +48 22 44 47 391

 + 48 22 44 47 379

 + 420 591 160 091

 +48 22 44 47 523
+48 22 44 47 338

 +375 291 504 626
+48 22 44 47 529

 +48 22 44 47 216
+48 22 44 47 338

 +48 22 44 47 525
+48 22 44 47 251

 +48 22 44 47 301
+48 22 44 47 586
+48 22 44 47 552

 тел: 8-495-640 15 88

 GTV Croatia d.o.o
Roberta Frangeša Mihanovica 9
10110 Zagreb
+ 385 1 798 8089

 GTV Czech Distribution s.r.o.
CTPark Ostrava, Na Rovince 879
720 00 Ostrava-Hrabová
Česká republika
+420 727 800 362
+420 725 715 142

 GTV España Herrajes e Iluminación,
S.L., Avenida Aragón 30, Planta 8
46021 Valencia (España)
+ 34 960 468 666
+ 48 22 444 73 77

fax: +48 22 444 75 01
e-mail: info@gtv.com.pl
www.gtv.com.pl

